

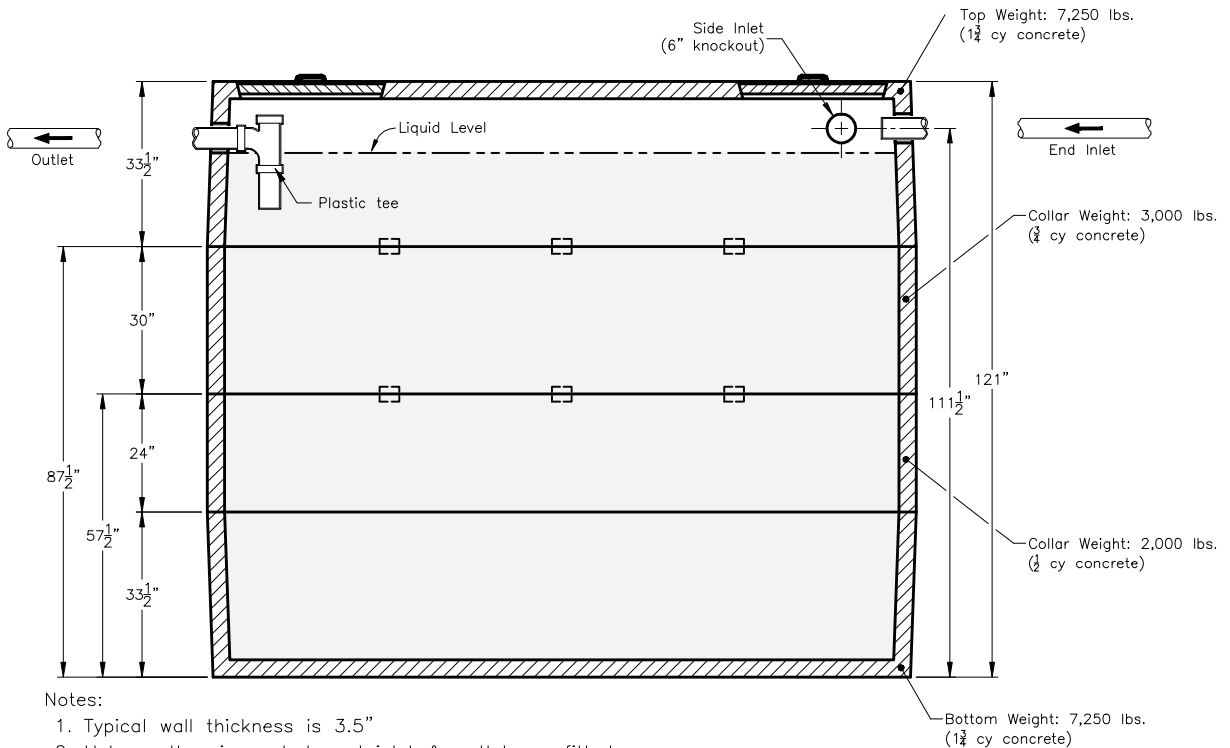

Precast Septic Tank

3742 West Front Street - Traverse City, MI 49684-8152 - 231-946-7880 - www.theconcreteservice.com

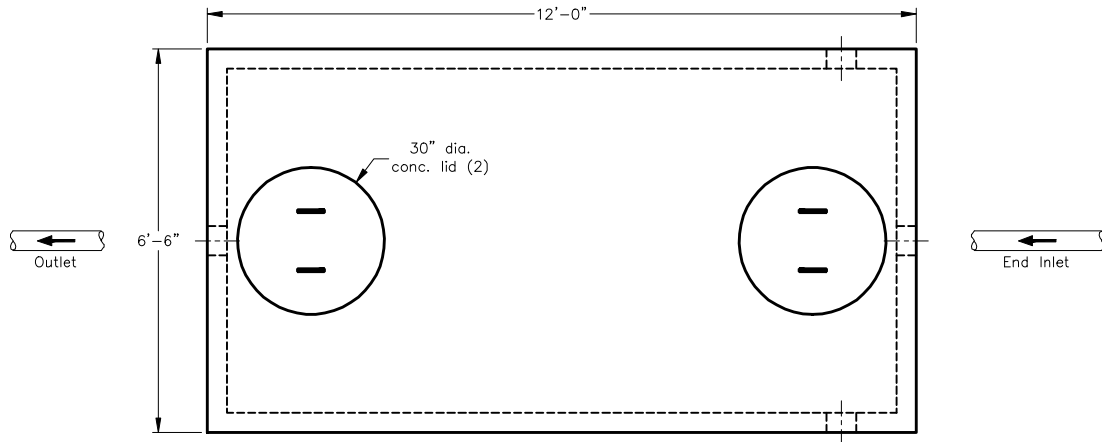

Notes:

1. Typical wall thickness is 3.5"
2. Unless otherwise noted, end inlet & outlet are fitted with polylock accepting pipes up to 6" dia.
3. Concrete access lid(s) shown are included
4. Plastic tees shown are included
5. Dimensions shown are approximate only
6. Tank may have internal support ribs or similar structures not shown above

#4350s-111

Outside Dim.	78W x 144L x 121H
Total Weight	21,500 lbs
Capacity	4,350 ga.